

Onity's AirSwitch ESD is a wireless DIN rail mounted energy saving device, based on room occupancy detection. It enables efficient energy management in different environments, saving up to 60% in electricity consumption.

The switch connects energy supply when it detects presence in a room or controlled area. The system runs automatically in conjunction with external detectors and it does not require the use of a keycard for its operation.

### Advantages

- **Energy savings** - It turns power off when the guest leaves the room, preventing waste when lighting and/or air conditioning are left on.
- **Cardless** - A card is not required for its operation
- **Comfort** - It features a temporized courtesy light
- Wireless communication through sensors, acting according to the presence status detected.

### Technical Specifications

Power	100-240 V~
Consumption	30 mA nominal (240 V~)
Output relay	2 relays free voltage with 2 contact N.O. Cutting power: 12 A, 240 V~, cos φ = 1
Wired inputs	1 door and 1 motion sensor
Frequency	50/60 Hz
Communication	2.4 GHz, IEEE 802.15.4 wireless
Pilot lights	Tricolour LED (amber, red and green)
Housing	ABS fireproof material (according to norm UL 94 V-0)
Module width	3
Dimensions	90.2 x 53.2 x 57.5 mm (H x W x D)
Weight	183 gr

### Default times

Unoccupied delay time	10'
Courtesy light after change to unoccupied mode	20'
HVAC deactivation after window opening	After 30''

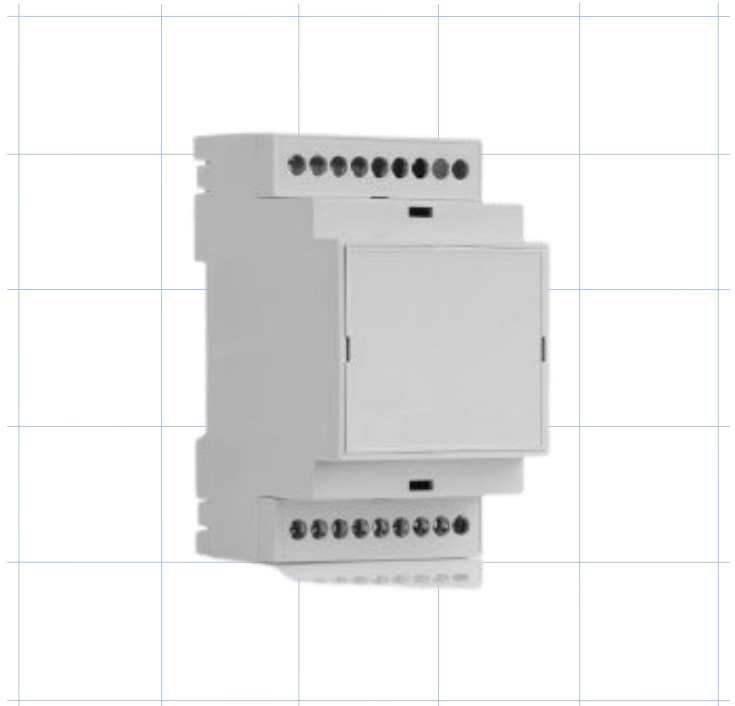

### Dimensions

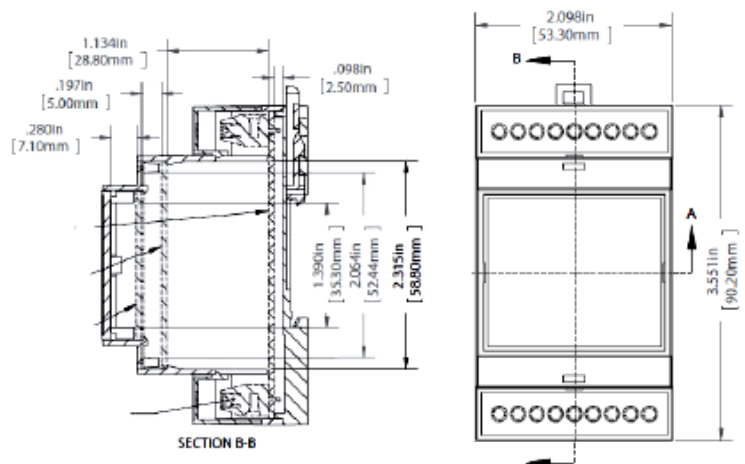
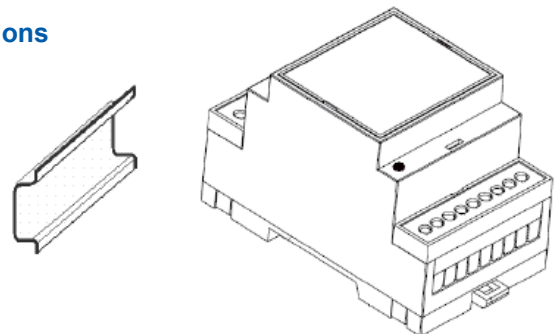

AirSwitch energy saving devices can generate saving of up to 60% in electricity consumption. This handheld unit is a programming device that allows to interact with the wireless energy savers.

### Features

- Status checking for energy savers and sensors
- Energy saver updates: change courtesy time, relay mode, etc.
- Wireless signal strength detection: checks the coverage from the energy saver to the sensor
- Energy saver configuration: enables configuring their parameters during commissioning.

### Technical Specifications

Power	2 x LR3 1,5 V batteries (AAA alkaline)
Communication	2.4 GHz, IEEE 802.15.4 wireless USB (Universal Serial Bus)
Display	128x64 pixel graphics display LED backlighting
Keyboard	Tactile membrane switch with 4 buttons
Cover	Manufactured with flame-resistant ABS UL94V-0. Material: Silicone
Dimensions	120 x 74 x 24 mm (H x W x D)
Weight	180 gr



### Dimensions

With silicone cover

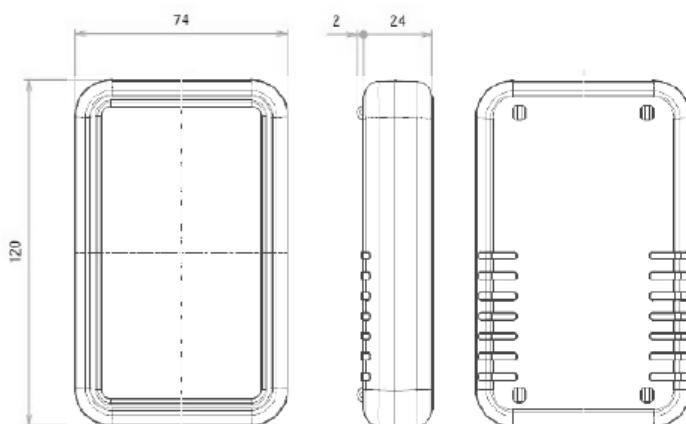

Without silicone cover

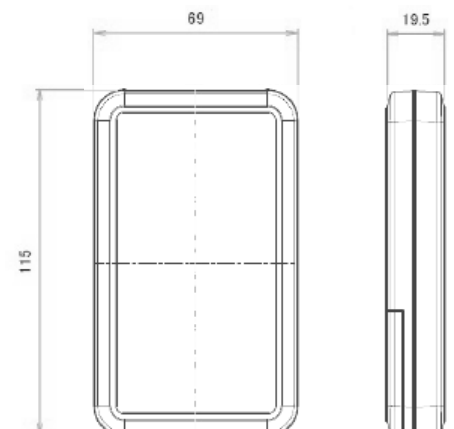

AirSwitch energy saving devices can generate savings of up to 60% in electricity consumption

The surface mounted ceiling sensor detects room occupancy status through motion and informs the energy saver through communicating wirelessly. The energy saver then manages the electric supply connection accordingly, to minimise consumption.

### Features

- Detects occupancy status and communicates with the saver, wirelessly
- Standalone, battery operated
- Surface mounted on the ceiling
- Multiple sensors can be placed per room
- It incorporates an embedded temperature sensor

### Technical Specifications

Power	3 x LR3 1,5 V batteries (AAA alkaline)
Battery life	4 years (30 uA average consumption, max. 20 mA) with alkaline batteries
Communication	2.4 GHz, IEEE 802.15.4 wireless
Communication coverage	10 m (max. distance to the energy saver)
Interface	Red LED
Temperature range	-10° to 50° C
Technology	Infrared passive detector Fresnel lens
Detection coverage	φ 6 m (for a height of 3 m) coverage according to mounting height
Assembly height	2.5 - 4 m
Thermostat precision:	±2° C (-10° to 50°)
Dimensions	φ 111 x 40 mm
Weight	120 gr



### Dimensions

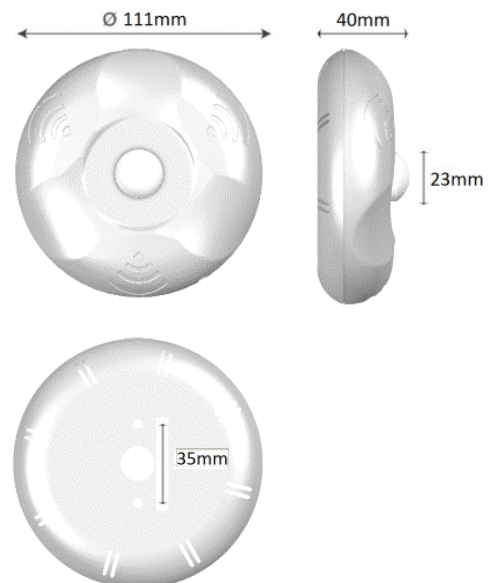

AirSwitch energy saving devices can generate savings of up to 60% in electricity consumption.

The flush mounted ceiling sensor detects room occupancy status through motion and informs the energy saver communicating wirelessly. The energy saver then manages the electric supply connection accordingly, to minimise consumption.

### Features

- Detects occupancy status and communicates with the saver, wirelessly
- Standalone, battery operated
- Flush mounted installation, on the ceiling
- Multiple sensors can be placed per room
- It incorporates embedded temperature and humidity sensors

### Technical Specifications

Power	1 x CR123A 3V lithium battery
Battery life	5 years (average consumption 18 uA, max. 20mA)
Communication	2.4 GHz, IEEE 802.15.4 wireless
Communication coverage	10 m (max. distance to the energy saver)
Interface	Red LED
Operating conditions	Temperature -40° to 160° C Humidity (0% rH to 100% rH)
Technology	Infrared passive detector
Detection coverage	6.9 x 5.8 m (for a height of 2.5 m)
Assembly height	12 m max. height
Thermostat precision:	
Temperature	±0.5° C (15° to 40°), ±1° F (0° to 60°)
Humidity	±3.5% (20% to 80%)
Dimensions	φ 85 x 37 mm
Weight	90 gr



### Dimensions

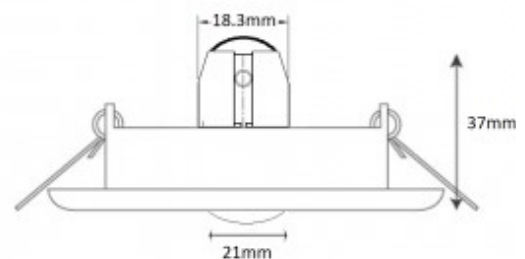
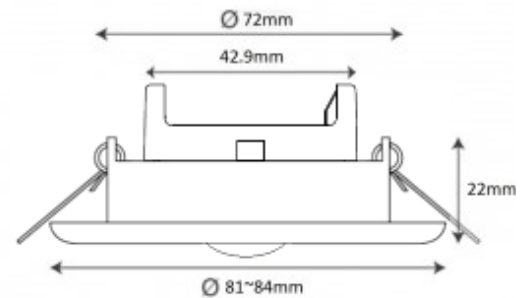

AirSwitch energy saving devices can generate savings of up to 60% in electricity consumption.

The surface door/window sensor detects when the room door or window opens and communicates the status to the energy saver wirelessly. The energy saver then manages the electric supply connection accordingly, to minimise consumption.

### Features

- Detects door/window status and communicates with the saver, wirelessly
- Standalone, battery operated
- To be installed on doors or windows (non-metallic recommended)
- Easy to install

### Technical Specifications

Power	1 x CR2032 3V lithium battery
Battery life	2 years (10 uA average consumption, max. 20 mA)
Communication	2.4 GHz, IEEE 802.15.4 wireless
Communication coverage	10 m (max. distance to the energy saver)
Interface	Red LED
Temperature range	-10° to 50° C
Technology	Magneto-resistive sensor + magnet
Sensor-magnet distance	0.8 cm max. A slight separation is recommended
Dimensions	Sensor: 44 x 27 mm
Dimensions	Magnet: 18.5 x 13.5 mm
Weight	14 gr



### Dimensions

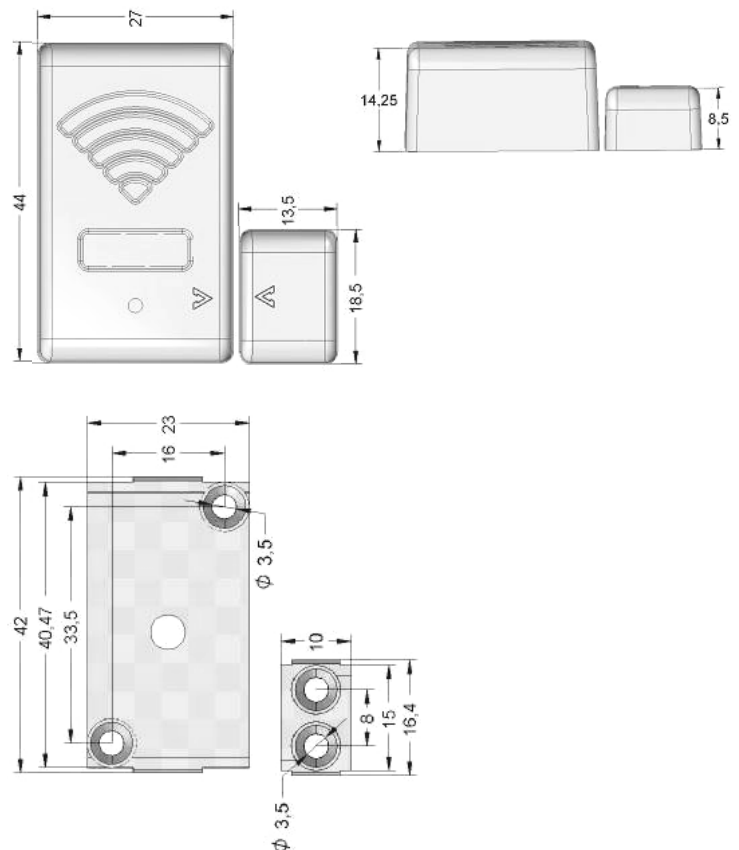

AirSwitch energy saving devices can generate savings of up to 60% in electricity consumption.

The flush mounted door/window sensor detects when the room door or window opens and communicates the status to the energy saver, wirelessly. The energy saver then manages the electric supply connection accordingly, to minimise consumption.

### Features

- Detects door/window status and communicates with the saver, wirelessly
- Standalone, battery operated
- To be installed on doors or windows (non-metallic recommended)
- Easy to install
- Concealed, it goes hidden inside the door or window, providing more safety against tampering

### Technical Specifications

Power	1 x LR3 1.5V battery (AAA alkaline)
Battery life	4 years (average consumption 14 uA, max. 20 mA) with 20 opening per day.
Communication	2.4 GHz, IEEE 802.15.4 wireless
Communication coverage	10 m (max. distance to the energy saver)
Interface	Red LED
Temperature range	-10° to 50° C
Technology	Magneto-resistive sensor + magnet
Sensor-magnet distance	2 cm max. A slight separation is recommended
Material	Latamid 6H2 G/30-VOCT1 (according to UL 94 V-0)
Dimensions	Sensor: $\phi$ 20 x 55.5 mm
Dimensions	Magnet: $\phi$ 25 x 2 mm
Weight	17 gr



### Dimensions

